

Einbauanleitung mit Estrichsockel

Poresta® BEDS Schallentkopplungsmatte (Grundset)

Mounting instructions with screed base

Poresta® BEDS antiresonant mat (basic set)

Montagehandleiding met estrikondergrond

Poresta® BEDS geluidsisolatiemat (grondset)

Instructions de montage avec socle de chape

Matelas d'isolation acoustique Poresta® BEDS (jeu de matériel de base)

Istruzioni di montaggio con zoccolo di pavimento

Stuoia d'isolamento acustico Poresta® BEDS (set base)

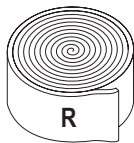

Poresta® Randdämmstreifen /
Edge insulation strips /
Randdichtingsstroken /
Bande isolante de bord /
Fascia isolante di bordo

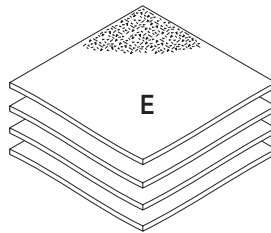

Poresta® Schallentkopplungsmatte /
Antiresonant mat /
Geluidsisolatiemat /
Matelas d'isolation acoustique /
Stuoia d'isolamento acustico

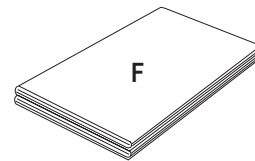

Poresta® Baufolie /
Construction foil /
Bouwfolie /
Feuille de bâtiment /
Foglio da costruzione

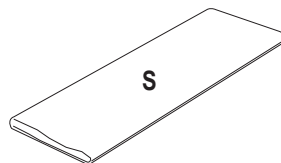

Poresta® Schalldämpfungsmatte /
Sound absorbing mat /
Geluiddeempingsmat /
Matelas insonorisant /
Stuoia insonorizzante



Poresta® Klebeband /
Adhesive strip /
Plakband /
Ruban adhésif /
Nastro adesivo

For notes and further information see page 6 /
Aanwijzingen en verdere informatie zie pagina 6 /
Renseignements et informations complémentaires, voir page 7 /
Riferimenti e ulteriori informazioni, vedi pagina 8

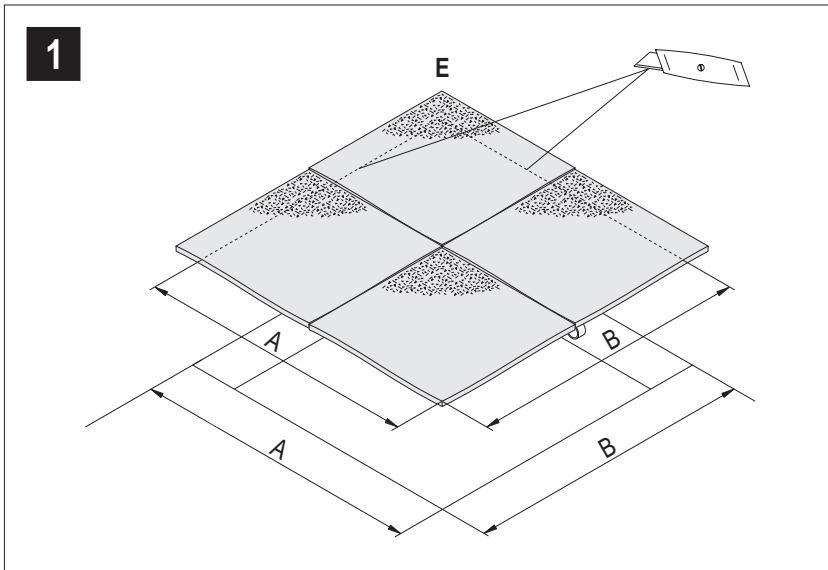

⚠ Die einschlägigen Verarbeitungsrichtlinien aller beteiligten Gewerke sind zu berücksichtigen.

⚠ Für die Verwendung des Schallschutzsets in Verbindung mit den Poresta® bodenebenen Duschsystemen sind Schallprüfzeugnisse verfügbar. Zur Einhaltung der gemessenen Installationsschallpegel müssen die aufgeführten Poresta® Produkte fachgerecht verwendet werden.

⚠ Direkter Kontakt des Estrich mit dem angrenzenden Boden und den Wänden ist zu vermeiden.

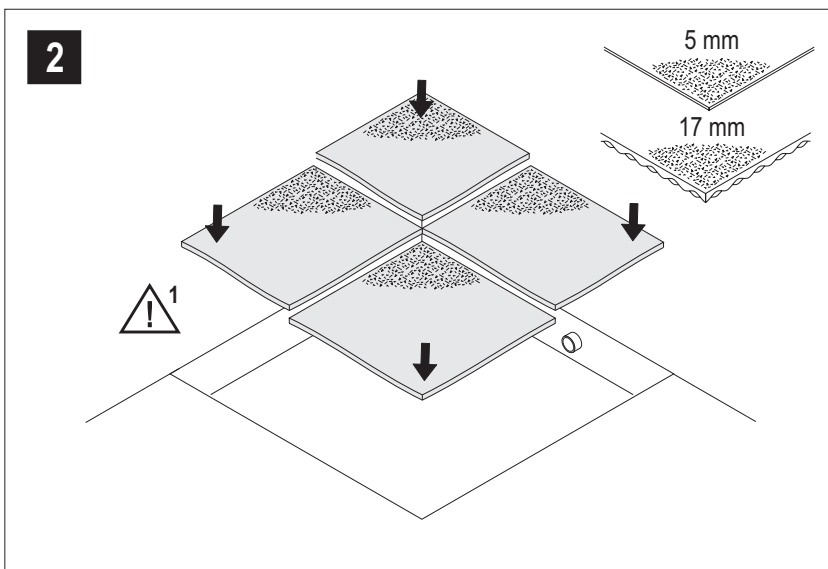

⚠ Für den Einbau muss ein ebener, sauberer, tragfähiger und schwingungsfreier Untergrund vorhanden sein.

⚠ Der Boden im Bereich des Duschsystems muss planeben sein (gegebenenfalls mit Ausgleichsmasse nacharbeiten).

⚠¹ Poresta® Schallentkopplungsmatte lose auflegen.

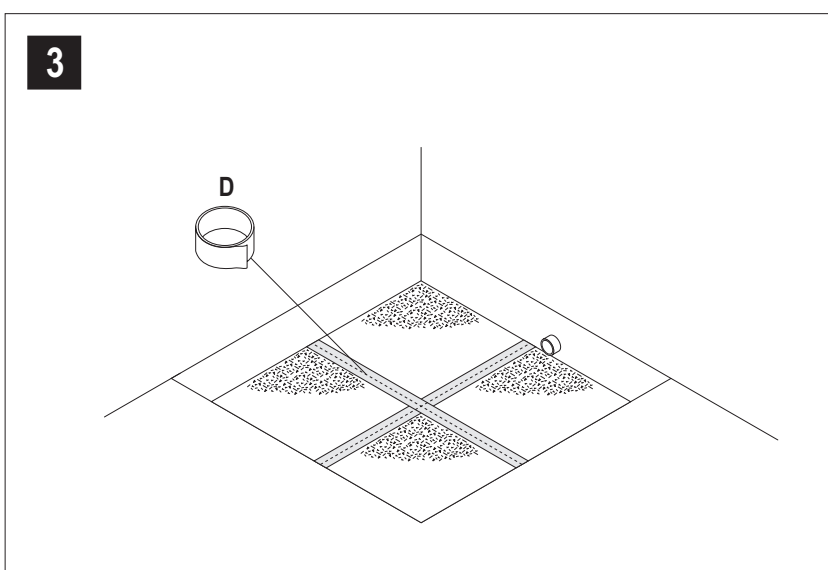

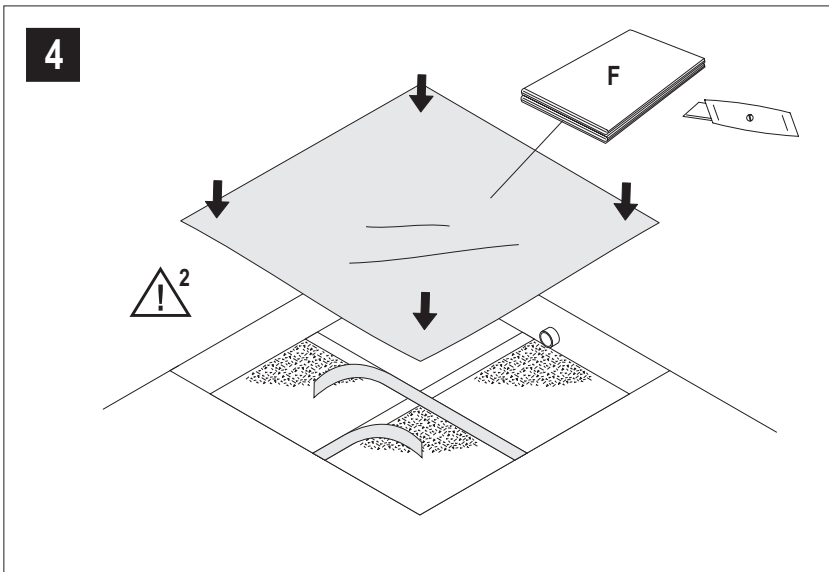

!² Schutzfolie vom Klebeband entfernen und Schallentkopplungsmatten vollflächig mit Baufolie abdecken.

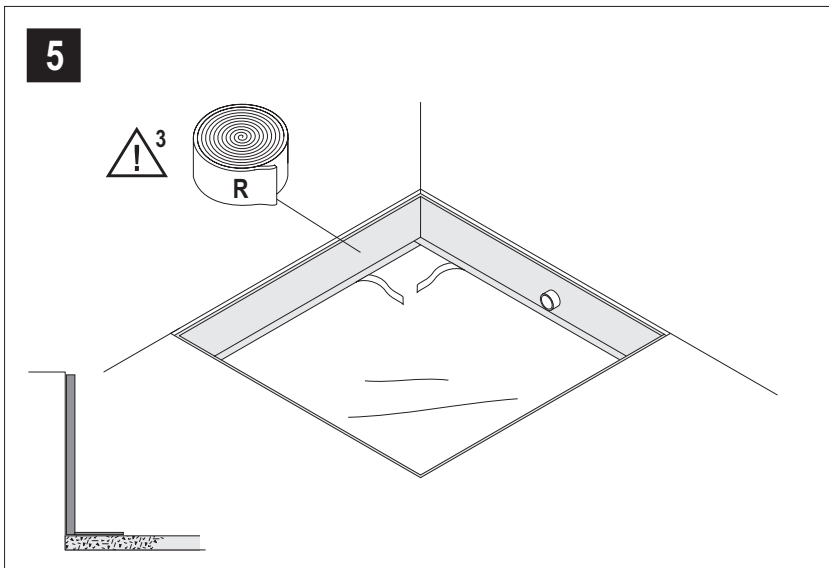

!³ Randdämmstreifen umlaufend auf die Baufolie kleben.

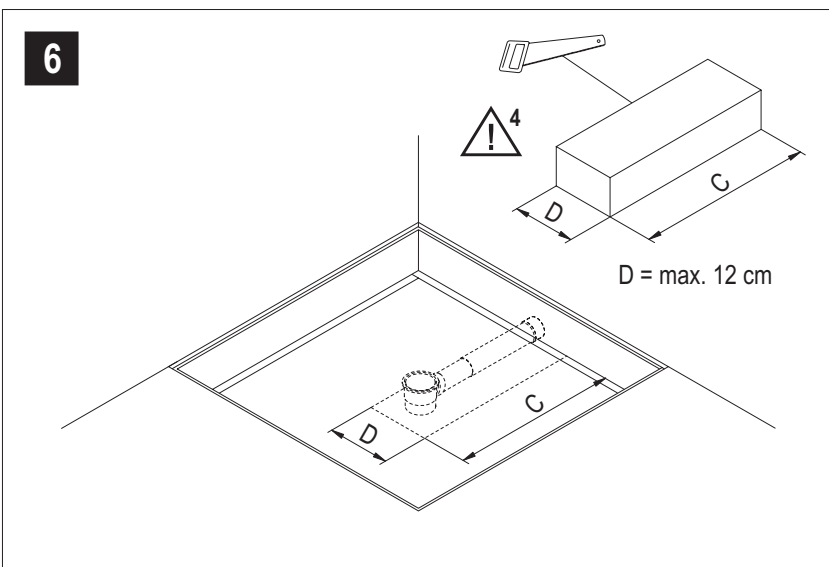

!⁴ Abaufführung mit Füllstück (nicht im Lieferumfang) aussparen.

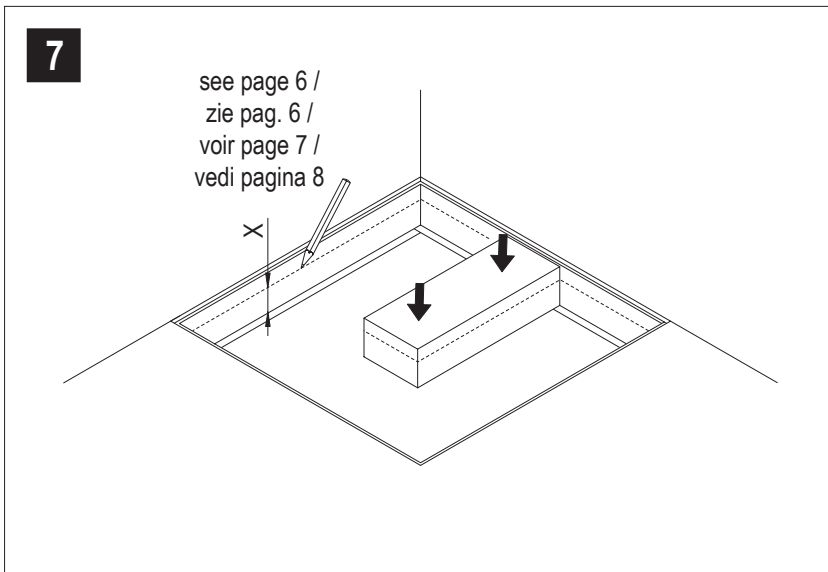

Ermittlung der Höhe des Estrichsockels ($X \geq 40$ mm):

Aufbauhöhe/Rohfussboden	140 mm
Schallentkopplungsmatte 5 mm	- 5 mm
Höhe Duschesystem* (max.)	- 45 mm
1 Lage Fliesenkleber	- 5 mm
Höhe (X)	= 85 mm

Aufbauhöhe/Rohfussboden	140 mm
Schallentkopplungsmatte 17 mm	- 17 mm
Höhe Duschesystem* (max.)	- 45 mm
1 Lage Fliesenkleber	- 5 mm
Höhe (X)	= 73 mm

* Beispiel für Duschesystem: BF KMK (900 x 900 x 45 mm, waagerechter Ablauf, zentriert)

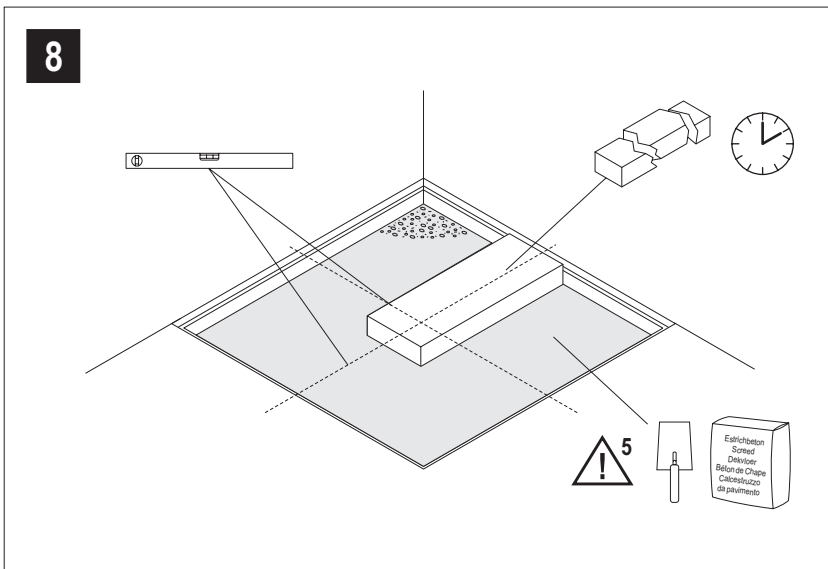

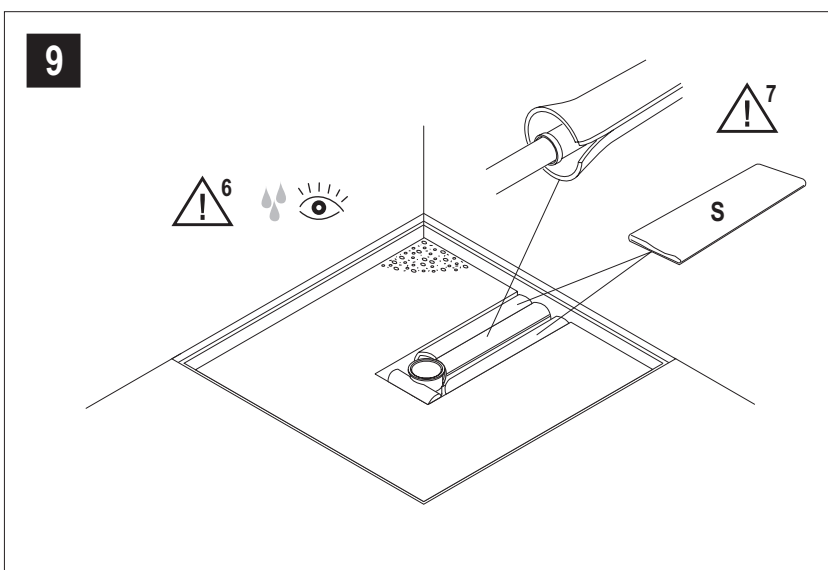

5 Die Verarbeitungshinweise und Aushärtzeiten des Estrichbetons sind zu beachten.





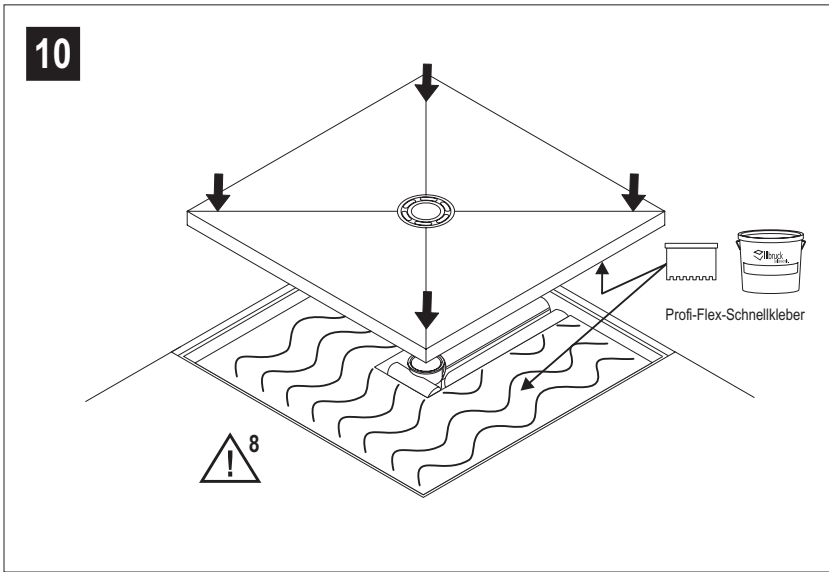









6 Nach Installation der Ablaufgarnitur ist eine Dichtigkeitsprüfung durchzuführen.

7 Vor dem Verschließen des Ablaufschachtes eine geeignete Wärme- und Schallschutzmantelung (nicht im Lieferumfang) an der Ablaufleitung anbringen. Hohlräume des Ablaufschachtes mit Zuschnitten der Schalldämpfungsmatte (S) ausfüllen.



 8 Der weitere Einbau des Duschelementes erfolgt gemäß der jeweiligen Einbauanleitung.

-  The relevant working guidelines of all the trades involved shall be observed.
-  Sound test certificates are available for the use of the sound proofing set in connection with the Poresta® flush shower systems. The Poresta® products must be used expertly to observe the measured installation sound level.
-  Direct contact of the screed with the adjacent concrete and walls should be avoided.
-  For installation, a flat, clean, firm and vibration-less substrate is required.
-  The floor in the area of the shower system should be absolutely flat (if necessary, rework with levelling compound).
-  ¹ Place the Poresta® soundproofing mat loosely in position.
-  ² Remove protective foil from adhesive strip and cover the antiresonant mat over the complete surface with construction foil.
-  ³ Stick edge insulation strips to the construction foil all around.
-  ⁴ Leave space for drain guide by means of filling piece (not included in the supply).
-  ⁵ The manufacturer's processing instructions and setting times of the screed concrete shall be observed.
-  ⁶ After the installation of the drain fitting, a leak test has to be carried out.
-  ⁷ Before closing the drain duct, provide the drain line with a suitable heat and sound insulation jacketing (not included in the scope of supply). The cavities of the drain duct are to be filled up with cut pieces of the sound absorbing mat (S).
-  ⁸ Further installation of the shower element is carried out in accordance with the relevant installation instructions.

Determination of the height of the screed base ($X \geq 40$ mm)

Mounting height/raw floor	140 mm
Antiresonant mat 5 mm	- 5 mm
Height of shower system* (max.)	- 45 mm
1 layer of tile adhesive	- 5 mm
Height (X)	= 85 mm
Mounting height/raw floor	140 mm
Antiresonant mat 17 mm	- 5 mm
Height of shower system* (max.)	- 45 mm
1 layer of tile adhesive	- 5 mm
Height (X)	= 73 mm













* Example for shower system: BF KMK (900 x 900 x 45 mm, horizontal outlet, centered)

-  Rekening houden met de verwerkingsrichtlijnen van alle betrokken leveranciers.
-  Voor de toepassing van de isolatieset in verbinding met Poresta® drempelloze douchesystemen zijn certificaten beschikbaar. Om de mogelijke grenswaarden te bereiken, moeten de genoemde Poresta® producten vakkundig worden verwerkt.
-  Direct contact van de estrik met de aangrenzende ondergrond en de wanden vermijden.
-  Voor montage is een vlakke, schone en zonder vibratie dragende ondergrond aanwezig te zijn.
-  De ondergrond voor het douchesysteem moet gelijkmatig vlak zijn (evt. met spachtelmateriaal bijwerken).
-  ¹ Poresta® geluidsisolatiemat los opleggen.
-  ² Verwijder beschermfolie van plakband en bedek geluidsisolatiemat over de hele oppervlakte met bouwfolie.
-  ³ Plak randdichtingsstroken rondom op de bouwfolie.
-  ⁴ Afvoergeleiding met vulstuk (niet in levering inbegrepen) uitsparen.
-  ⁵ De verwerkingsrichtlijnen en hardingstijden van het estrikketon moeten worden aangehouden.
-  ⁶ Na installatie van de afvoergarnituur op dichtheid testen.
-  ⁷ Voor het afsluiten van de afvoerschacht geschikte warmte- en geluidsisolatiemantel (niet in levering inbegrepen) rond de afvoerleiding aanbrengen. Holtes in de afvoerschacht met passend stukken van de geluiddempingsmat (S) opvullen.
-  ⁸ De verdere installatie van het douche-element volgens de betreffende handleiding.

Berekening hoogte estrikondergrond ($X \geq 40$ mm):

Opbouwhoogte/ruwe vloer	140 mm
Geluidsisolatiemat 5 mm	- 5 mm
Hoogte douchesysteem* (max.)	- 45 mm
1 Laag tegellijm	- 5 mm
Hoogte (X)	= 85 mm
Opbouwhoogte/ruwe vloer	140 mm
Geluidsisolatiemat 17 mm	- 17 mm
Hoogte douchesysteem* (max.)	- 45 mm
1 Laag tegellijm	- 5 mm
Hoogte (X)	= 73 mm













* Voorbeeld voor douchesysteem: BF KMK (900 x 900 x 45 mm, horizontale afloop, gecentreerd)

-  Les instructions correspondantes de mise en oeuvre de tous les métiers participants sont à respecter.
-  Pour l'utilisation du matériel d'insonorisation en relation avec des systèmes de douche Poresta® à sol plan, des certificats de contrôle du bruit sont disponibles. Pour obtenir les niveaux sonores d'installation mesurés, il est nécessaire d'effectuer la mise en oeuvre des produits Poresta® indiqués conformément aux règles de l'art.
-  Eviter le contact direct entre la chape et le sol adjacent et les murs.
-  Pour le montage, il est nécessaire d'avoir une surface plane, propre, stable et exempte de vibrations.
-  Le sol dans la zone du système de douche doit être plan (le cas échéant, faire des retouches au moyen de masse d'égalisation).
-  ¹ Poser le matelas d'insonorisation Poresta® sans le fixer.
-  ² Enlever la feuille de protection du ruban adhésif et couvrir toute la surface des matelas d'isolation acoustique de feuille de bâtiment.
-  ³ Coller la bande isolante de bord tout autour de la feuille de bâtiment.
-  ⁴ Réserver de l'espace pour le guidage de la conduite d'évacuation avec pièce intercalaire (pas comprise dans la fourniture).
-  ⁵ Respecter le mode de mise en oeuvre et les temps de prise du béton de la chape indiqués par le fabricant.
-  ⁶ Après le montage de la garniture d'écoulement, procéder à une épreuve d'étanchéité.
-  ⁷ Avant de fermer le conduit d'évacuation, la tuyauterie d'évacuation doit être pourvue d'une enveloppe calorifuge et insonorisante appropriée (pas comprise dans la fourniture). Remplir les vides de la conduite d'évacuation de pièces coupées dans le matelas d'isolation acoustique (S).
-  ⁸ L'installation ultérieure des éléments de douche est à effectuer conformément aux instructions de montage respectives.

Détermination de la hauteur du socle de chape ($X \geq 40$ mm):

Hauteur de montage/plancher brut	140 mm
Matelas d'isolation acoustique 5 mm	- 5 mm
Hauteur système de douche* (max.)	- 45 mm
1 couche de colle pour carreaux	- 5 mm
Hauteur (X)	= 85 mm
Hauteur de montage/plancher brut	140 mm
Matelas d'isolation acoustique 17 mm	- 17 mm
Hauteur système de douche* (max.)	- 45 mm
1 couche de colle pour carreaux	- 5 mm
Hauteur (X)	= 73 mm

* Exemple pour système de douche: BF KMK (900 x 900 x 45 mm, tuyau d'écoulement horizontal, centré)

-  Si deve osservare le istruzioni corrispondenti di lavorazione di tutti i mestieri partecipanti.
-  Per l'utilizzazione del materiale d'insonorizzazione in relazione al sistema di doccia Poresta® a fondo piano sono disponibili certificati di controllo del rumore. Per ottenere i livelli sonori d'installazione misurati è necessario di far attenzione alla messa in opera a regola d'arte dei prodotti Poresta® indicati.
-  Evitare il contatto diretto fra pavimento e fondo adiacente e pareti.
-  Per il montaggio è necessario di avere una superficie piana, pulita, stabile ed esente da vibrazioni.
-  Il pavimento nella zona del sistema di doccia deve essere piano (eventualmente correggere con massa d'appianamento).
-  **1** Posare la stuoia d'isolamento acustico Poresta® senza fissarla.
-  **2** Rimuovere foglio di protezione dal nastro adesivo e coprire stuoie d'isolamento acustico con foglio da costruzione per tutta la superficie.
-  **3** Incollare fasce isolanti di bordo tutt'intorno sul foglio da costruzione.
-  **4** Lasciar spazio per guida di scarico con pezzo di riempimento (non incluso in fornitura).
-  **5** Le istruzioni di lavorazione ed i tempi d'indurimento indicati dal fabbricante sono da osservare.
-  **6** Dopo l'installazione del gruppo di scolo, si deve procedere ad una prova di tenuta.
-  **7** Prima di fermare il canale di scolo, la condotta di scarico deve essere provvista di un rivestimento termoisolante e insonorizzante appropriato (non compreso nella fornitura). Riempire cavità del canale di scolo con pezzi tagliati della stuoia insonorizzante (S).
-  **8** L'installazione ulteriore dell'elemento di doccia deve essere eseguita in conformità alle istruzioni di montaggio rispettive.

Determinazione dell'altezza dello zoccolo del pavimento a smalto (X ≥ 40 mm):

Altezza di montaggio/pavimento grezzo	140 mm
Stuoia d'isolamento acustico 5 mm	- 5 mm
Altezza sistema di doccia* (max.)	- 45 mm
1 strato di collante da piastrelle	- 5 mm
Altezza (X)	= 85 mm
Altezza di montaggio/pavimento grezzo	140 mm
Stuoia d'isolamento acustico 17 mm	- 17 mm
Altezza sistema di doccia* (max.)	- 45 mm
1 strato di collante da piastrelle	- 5 mm
Altezza (X)	= 73 mm

* Esempio per sistema di doccia: BF KMK (900 x 900 x 45 mm, tubo di scolo orizzontale, centrato)